

Kobi Standard
KOBI

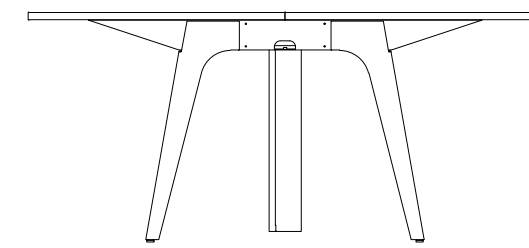
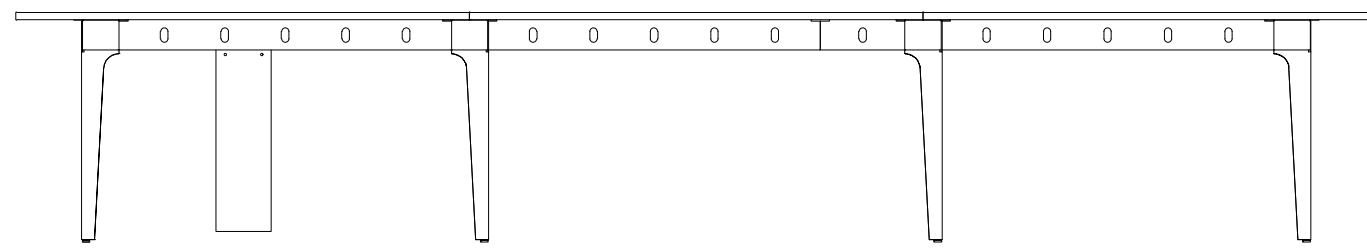
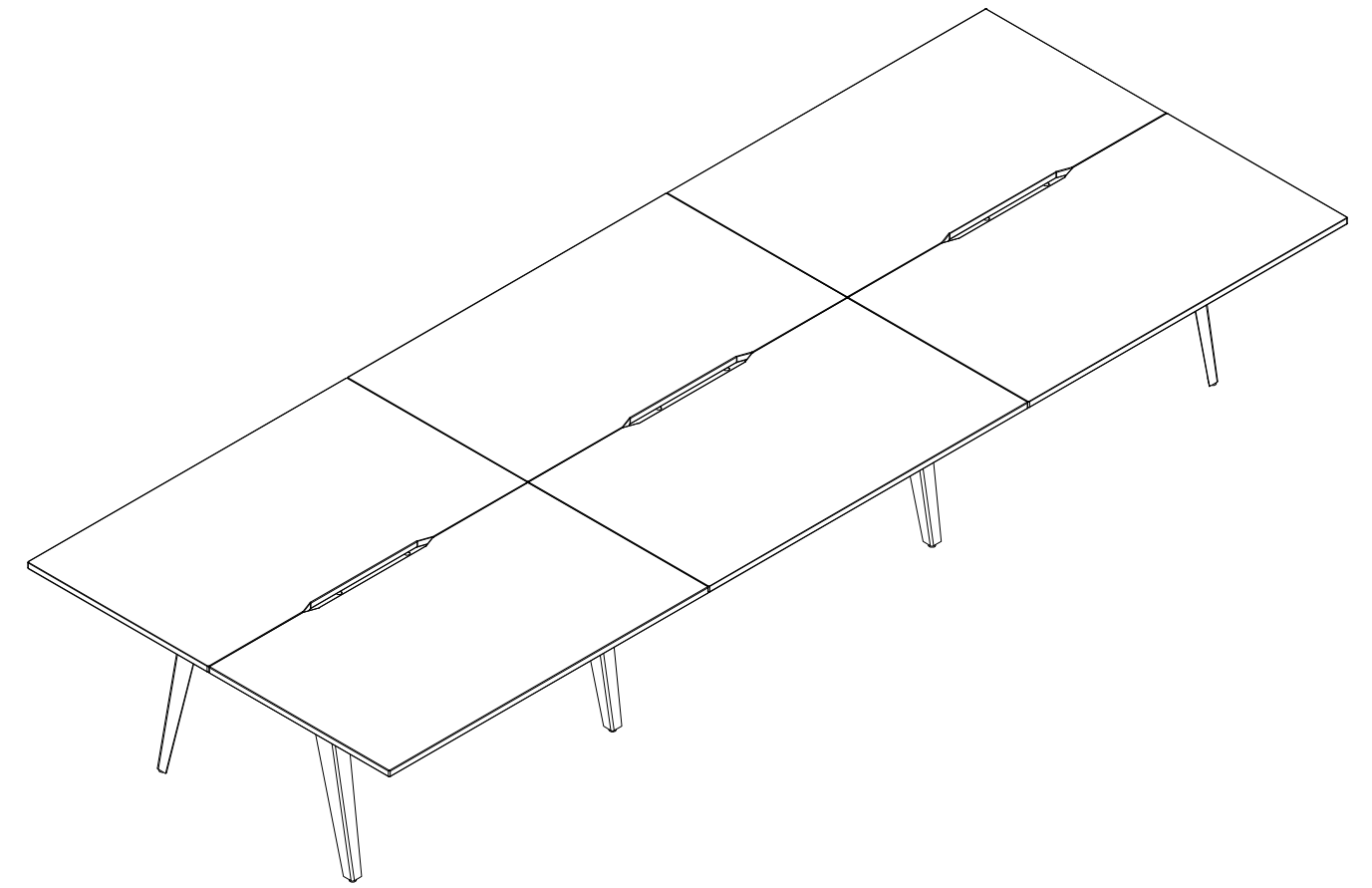
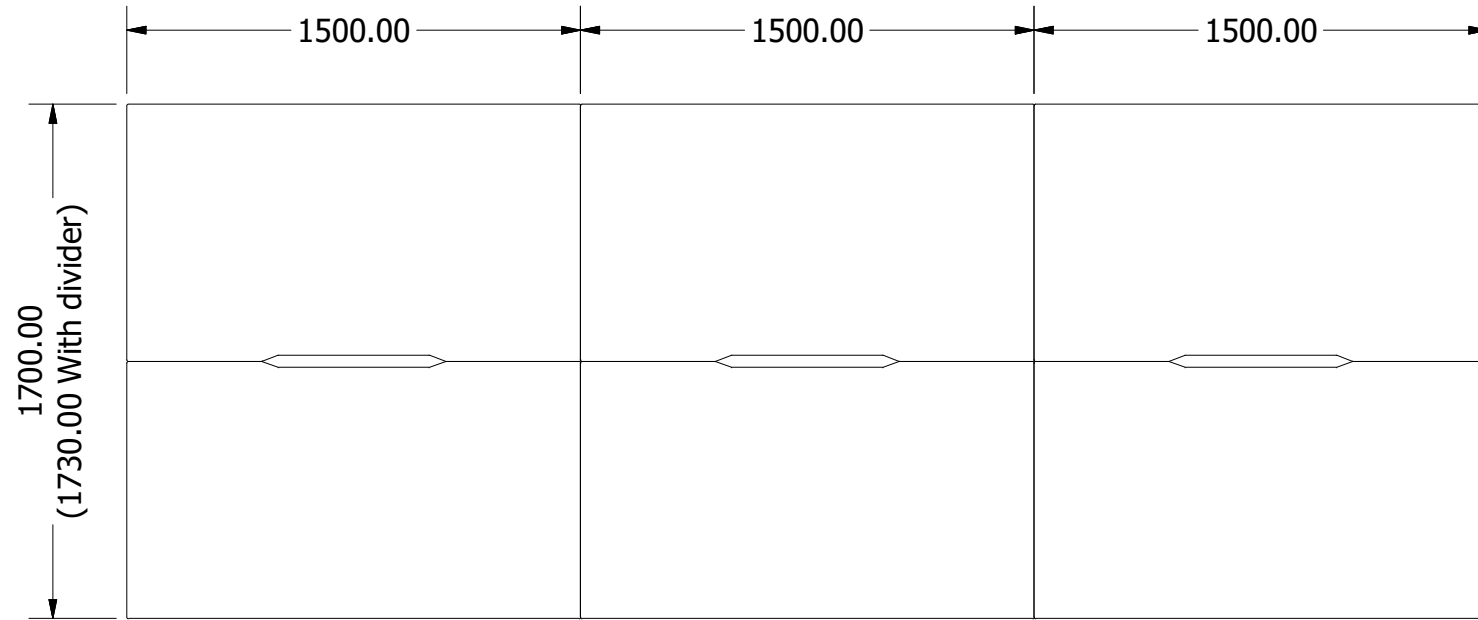

NB: All dimensions are +/- 5mm

Rev	Description	Date
A	Issued for manufacture	16/01/19

Notes:
General Tolerance ± 0.2
Angular Tolerance ± 0.5
Hole Position ± 0.2
Unless otherwise stated all dimensions are in millimetres
Remove all sharp edges to BS308: 1984 Parts 1, 2 and 3.

DO NOT SCALE IF IN DOUBT ASK

THIS DRAWING IS THE PROPERTY OF PERFORMANCE ENCLOSURES LIMITED AND THE INFORMATION CONTAINED HEREIN IS CONFIDENTIAL. THE DRAWING MAY NOT BE COPIED, USED OR DISCLOSED EXCEPT WITH WRITTEN PERMISSION OF AND IN THE MANNER PERMITTED BY THE PROPRIETORS.

Material:	
Finish:	
Drawn: S.Hack	Approved:
Checked:	Scale: 1 : 12

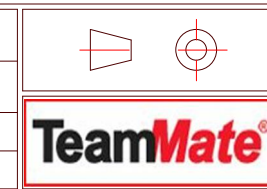

Drawing Title: KOBI
Drawing No.:
Sheet 1 of 4

**Kobi Standard
KOB**

2 person desk
4 person meeting table

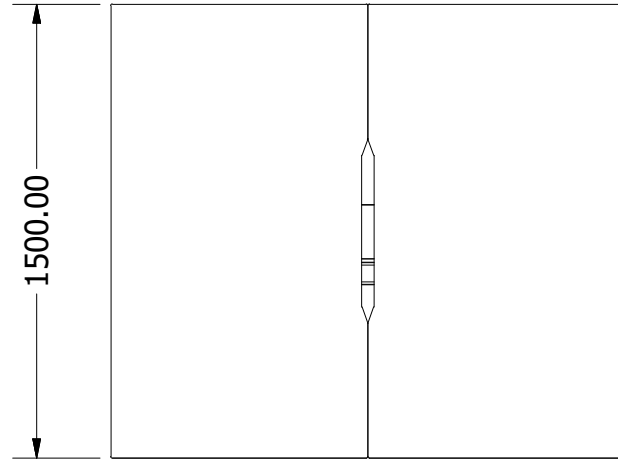

4 person desk
8 person meeting table

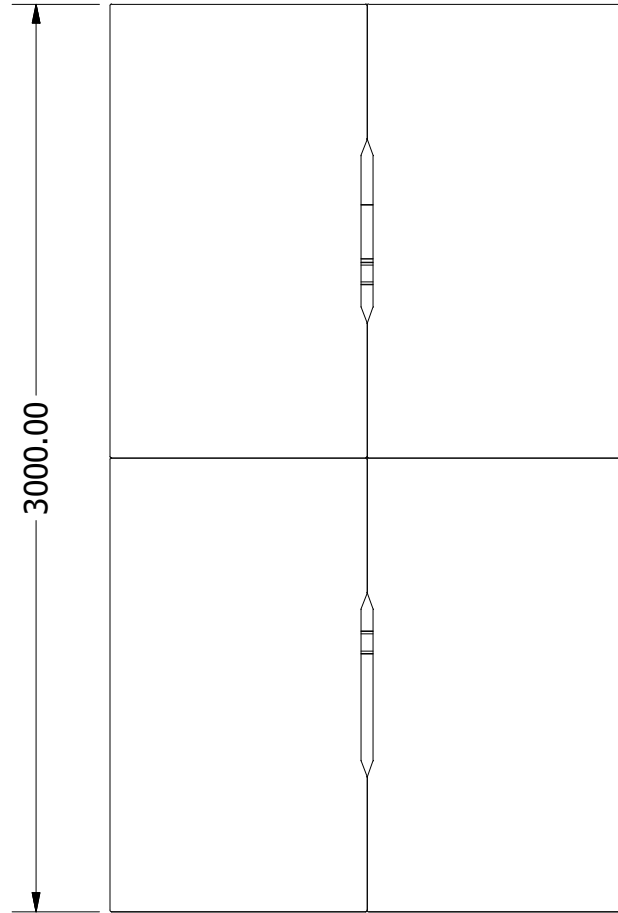

6 person desk
12 person meeting table

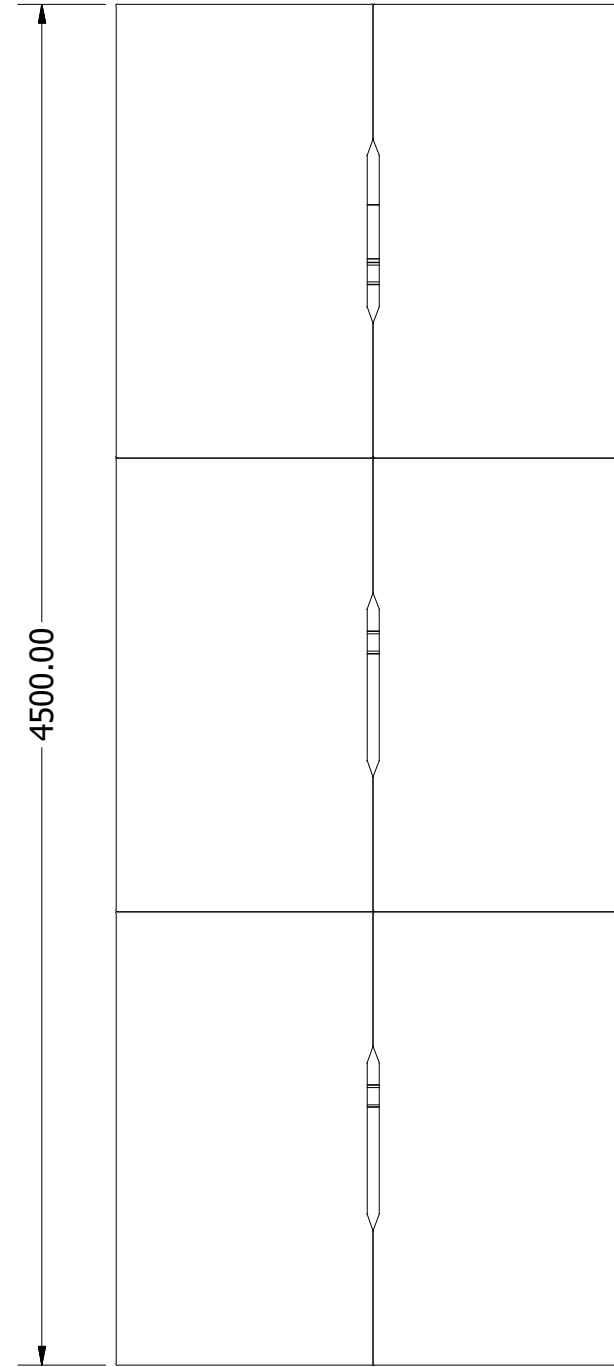

X person desk
(2X) person meeting table

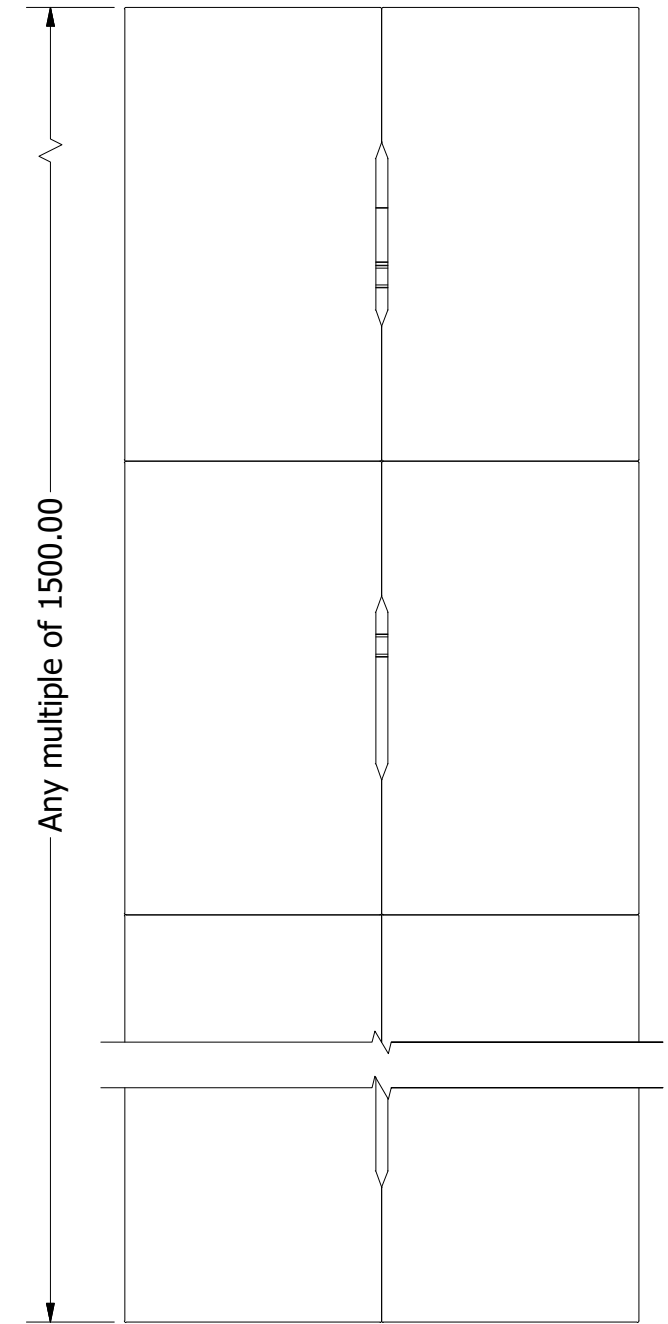

NB: All dimensions are +/- 5mm

Rev	Description	Date
A	Issued for manufacture	16/01/19

Notes:
General Tolerance ± 0.2
Angular Tolerance ± 0.5
Hole Position ± 0.2
Unless otherwise stated all dimensions are in millimetres
Remove all sharp edges to BS308: 1984 Parts 1,2 and 3.

DO NOT SCALE IF IN DOUBT ASK

THIS DRAWING IS THE PROPERTY OF PERFORMANCE ENCLOSURES LIMITED AND THE INFORMATION CONTAINED HEREIN IS CONFIDENTIAL. THE DRAWING MAY NOT BE COPIED, USED OR DISCLOSED EXCEPT WITH WRITTEN PERMISSION OF AND IN THE MANNER PERMITTED BY THE PROPRIETORS.

Material:	
Finish:	
Drawn: S.Hack	Approved:
Checked:	Scale: 1 : 12



Drawing Title: KOB
Drawing No.:
Sheet 2 of 4

**Kobi Premium
KOBİ**

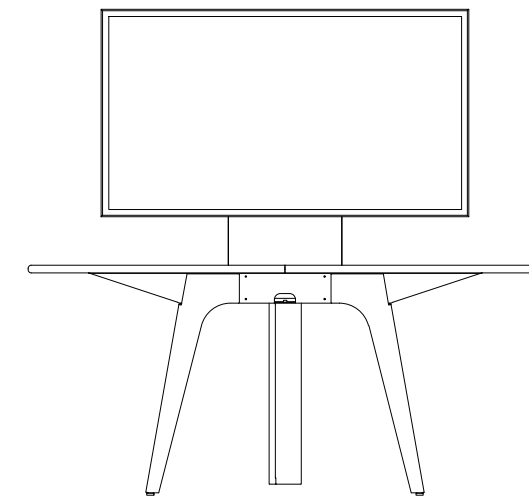
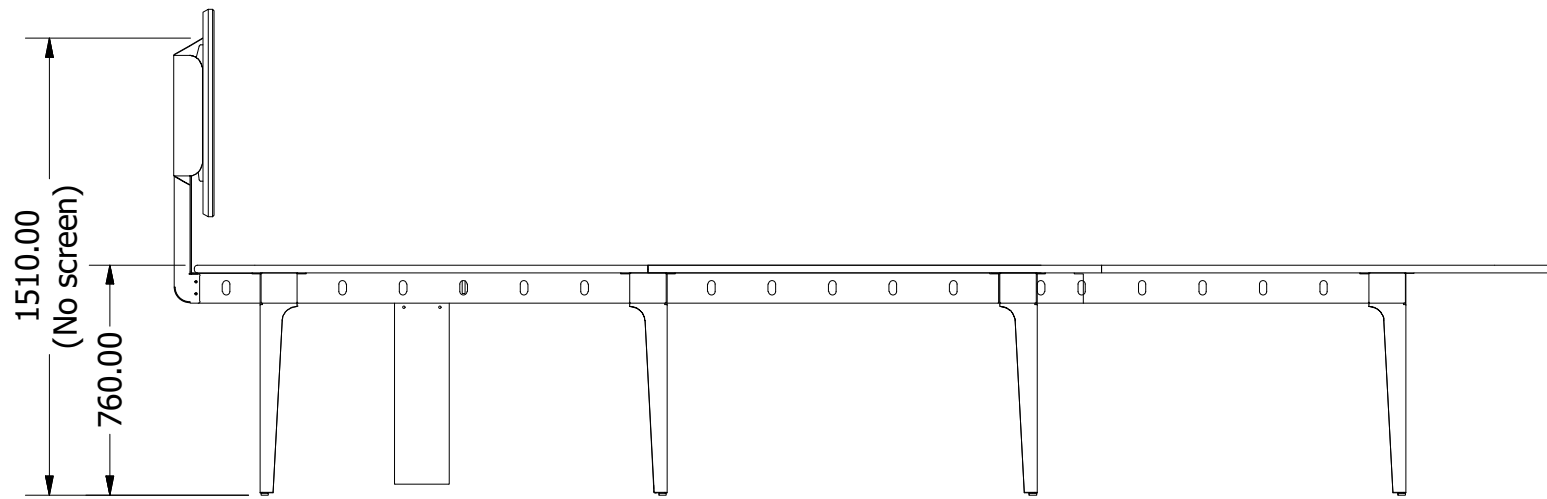
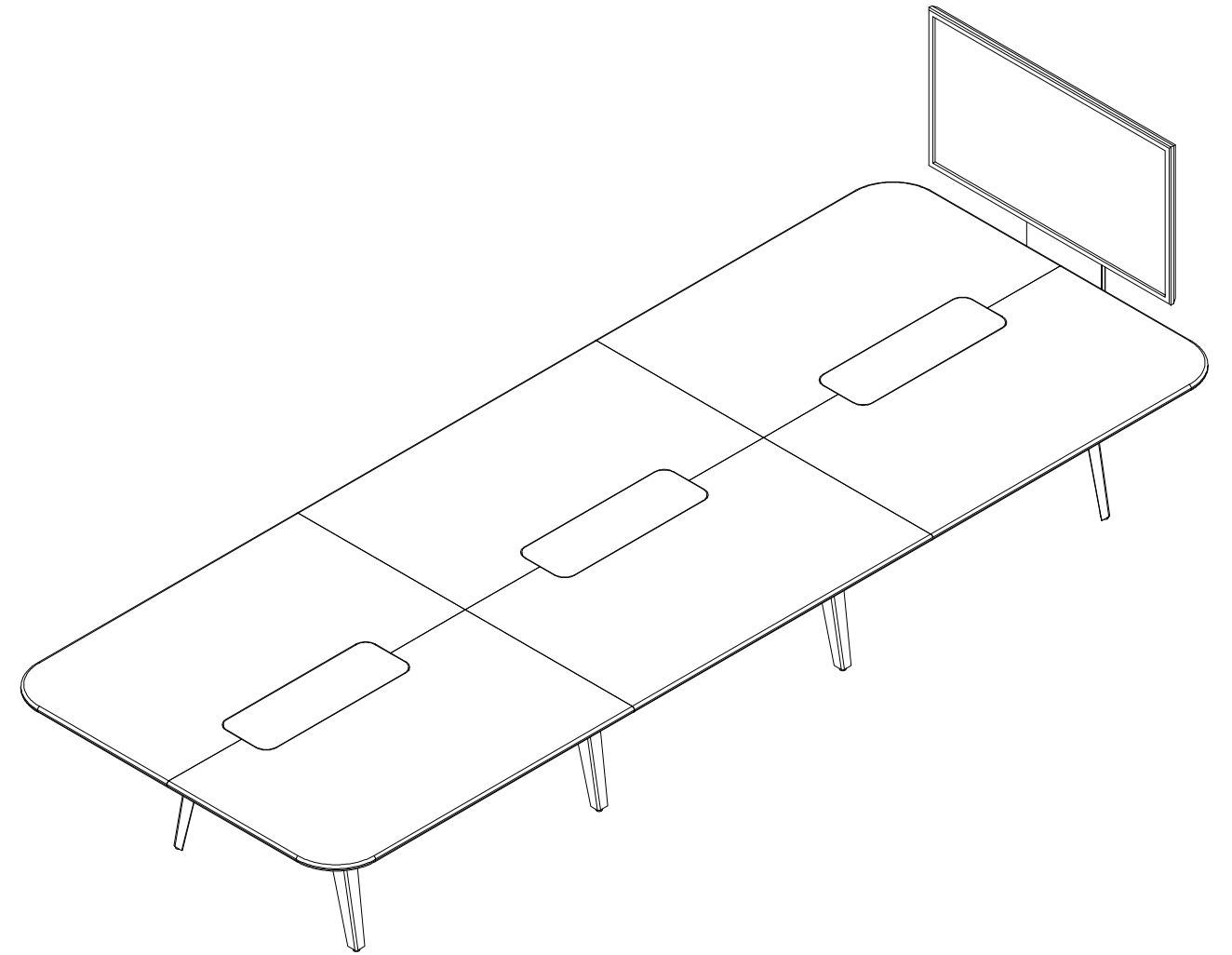
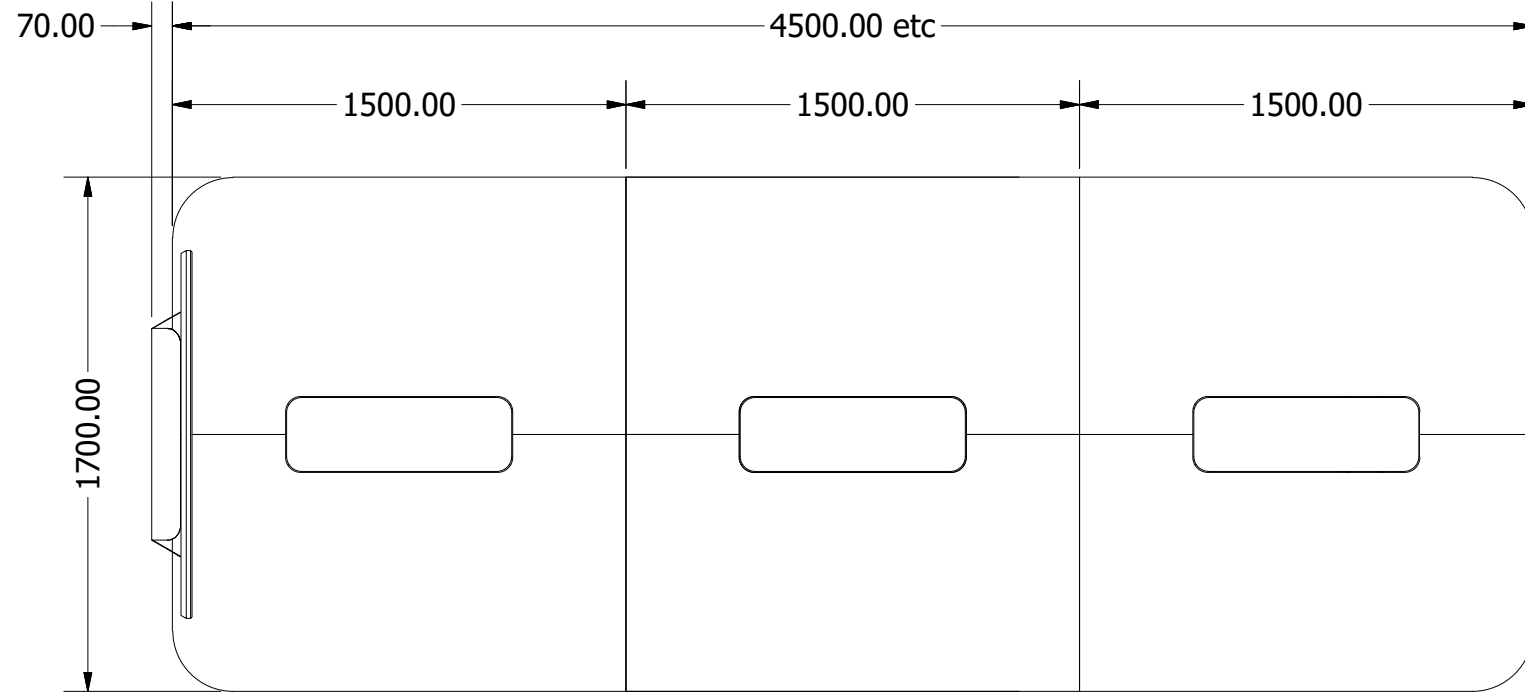

NB: All dimensions are +/- 5mm

Rev	Description	Date
A	Issued for manufacture	16/01/19

Notes:
General Tolerance ± 0.2
Angular Tolerance ± 0.5
Hole Position ± 0.2
Unless otherwise stated all dimensions are in millimetres
Remove all sharp edges to BS308: 1984 Parts 1,2 and 3.

DO NOT SCALE IF IN DOUBT ASK

THIS DRAWING IS THE PROPERTY OF PERFORMANCE ENCLOSURES LIMITED AND THE INFORMATION CONTAINED HEREIN IS CONFIDENTIAL. THE DRAWING MAY NOT BE COPIED, USED OR DISCLOSED EXCEPT WITH WRITTEN PERMISSION OF AND IN THE MANNER PERMITTED BY THE PROPRIETORS.

Material:	
Finish:	
Drawn: S.Hack	Approved:
Checked:	Scale: 1 : 12



Drawing Title: KOBİ
Drawing No.:
Sheet 3 of 4

Kobi Premium
KOBI

4 person desk
8 person meeting table

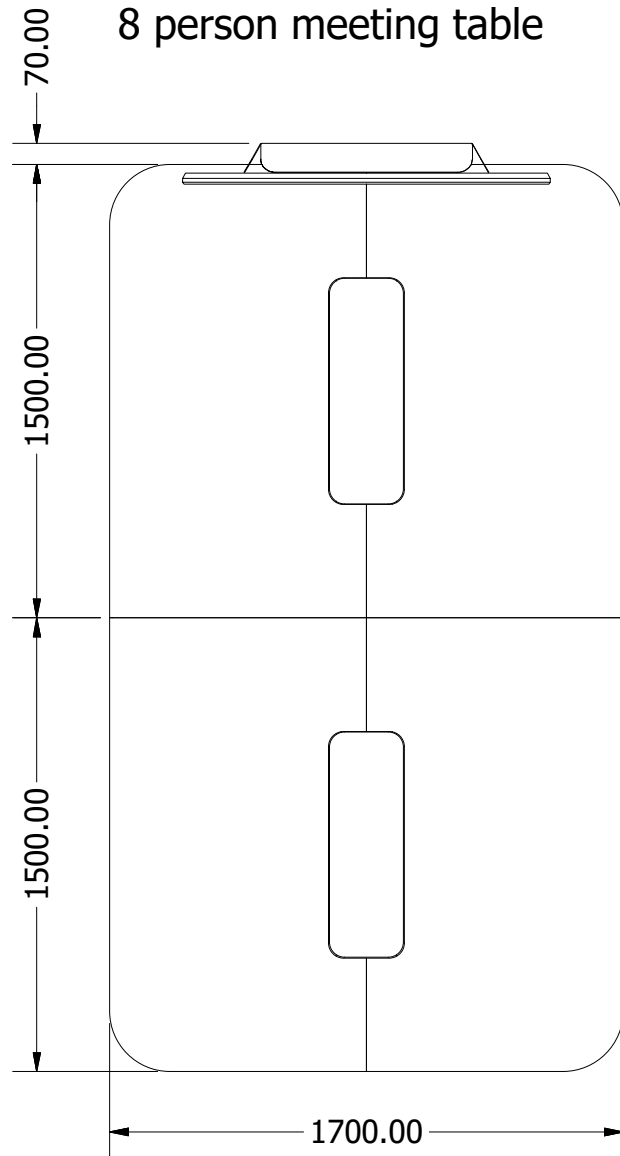

6 person desk
12 person meeting table

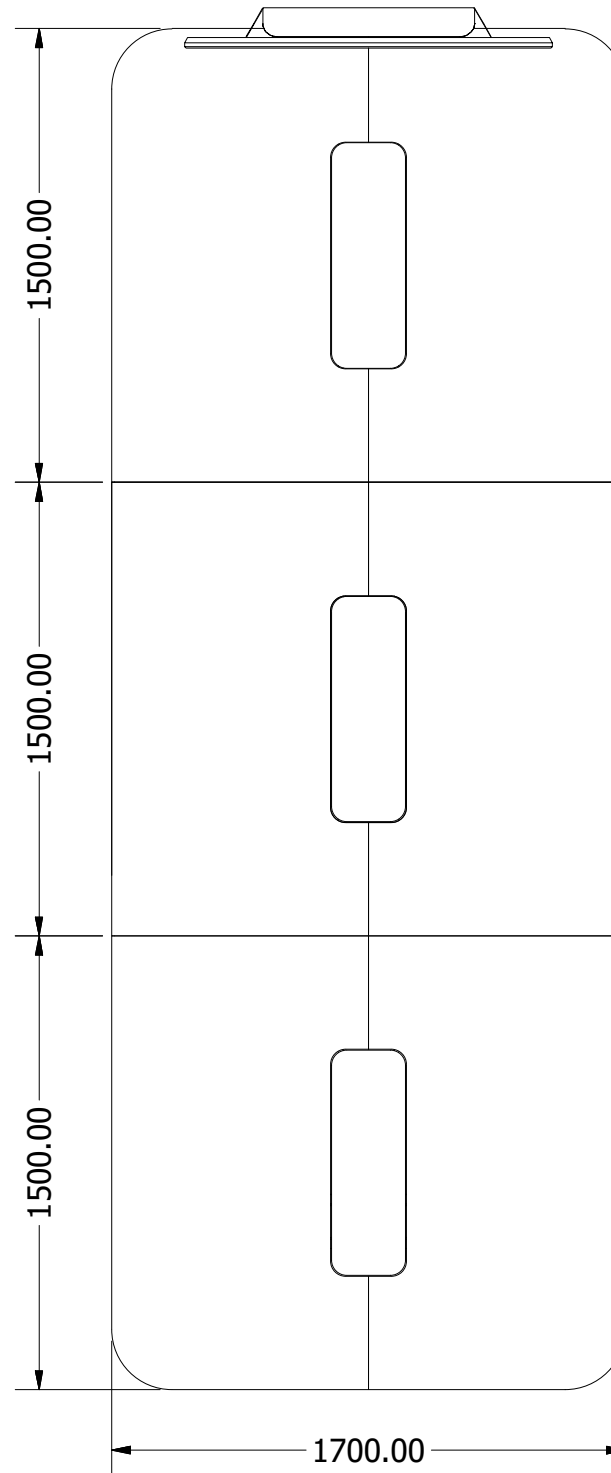

X person desk
(2X) person meeting table

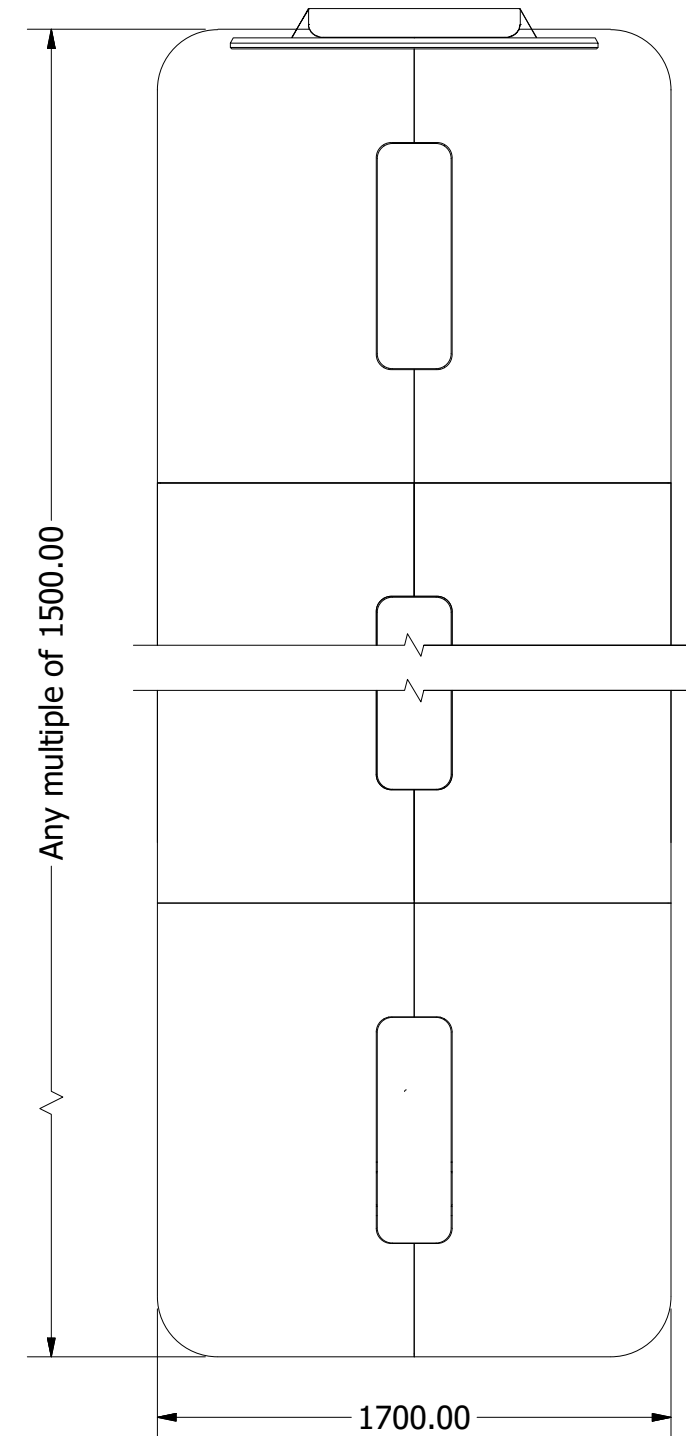

NB: All dimensions are +/- 5mm

Rev	Description	Date
A	Issued for manufacture	16/01/19

Notes:
General Tolerance ± 0.2
Angular Tolerance ± 0.5
Hole Position ± 0.2
Unless otherwise stated all dimensions are in millimetres
Remove all sharp edges to BS308: 1984 Parts 1,2 and 3.

DO NOT SCALE IF IN DOUBT ASK

THIS DRAWING IS THE PROPERTY OF PERFORMANCE ENCLOSURES LIMITED AND THE INFORMATION CONTAINED HEREIN IS CONFIDENTIAL. THE DRAWING MAY NOT BE COPIED, USED OR DISCLOSED EXCEPT WITH WRITTEN PERMISSION OF AND IN THE MANNER PERMITTED BY THE PROPRIETORS.

Material:	
Finish:	
Drawn: S.Hack	Approved:
Checked:	Scale: 1 : 12



Drawing Title: KOBI
Drawing No.:
Sheet 4 of 4